

**General Information**

**1**

**TTL Devices**

**2**

**Mechanical Data**

**3**



## Mechanical Data

Electrical characteristics presented in this data book, unless otherwise noted, apply for circuit type(s) listed in the page heading regardless of package. The availability of a circuit function in a particular package is denoted by an alphabetical reference above the pin-connection diagram(s). These alphabetical references refer to mechanical outline drawings shown in this section.

Factory orders for circuits described in this catalog should include a four-part type number as explained in the following example.

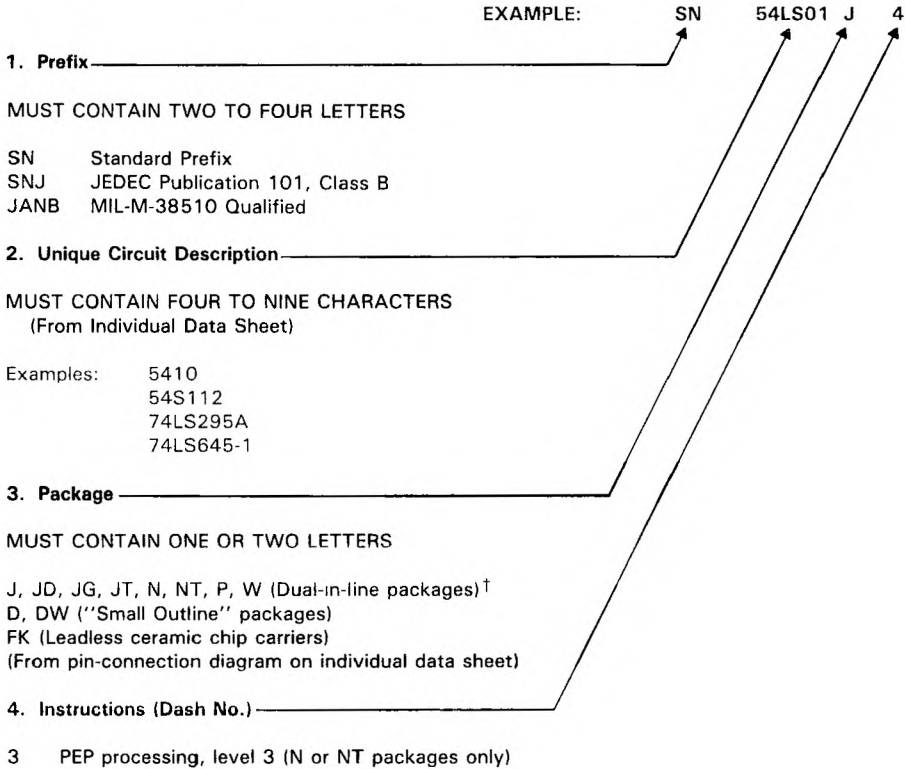

<sup>†</sup>These circuits in dual-in-line packages are shipped in one of the carriers shown below. Unless a specific method of shipment is specified by the customer (with possible additional costs), circuits will be shipped in the most practical carrier. Please contact your TI sales representative for the method that will best suit your particular needs.

Dual-in-line (D, DW, J, JD, JG, JT, N, NT, P, W)

- Slide Magazines
- A-Channel Plastic Tubing
- Tape and Reel
- Barnes Carrier (W only)
- Sectioned Cardboard Box
- Individual Plastic Box

**Mechanical Data**



## Mechanical Data

D008, D014, and D016 plastic "small outline" packages

Each of these "small outline" packages consists of a circuit mounted on a lead frame and encapsulated within a plastic compound. The compound will withstand soldering temperature with no deformation, and circuit performance characteristics will remain stable when operated in high-humidity conditions. Leads require no additional cleaning or processing when used in soldered assembly.

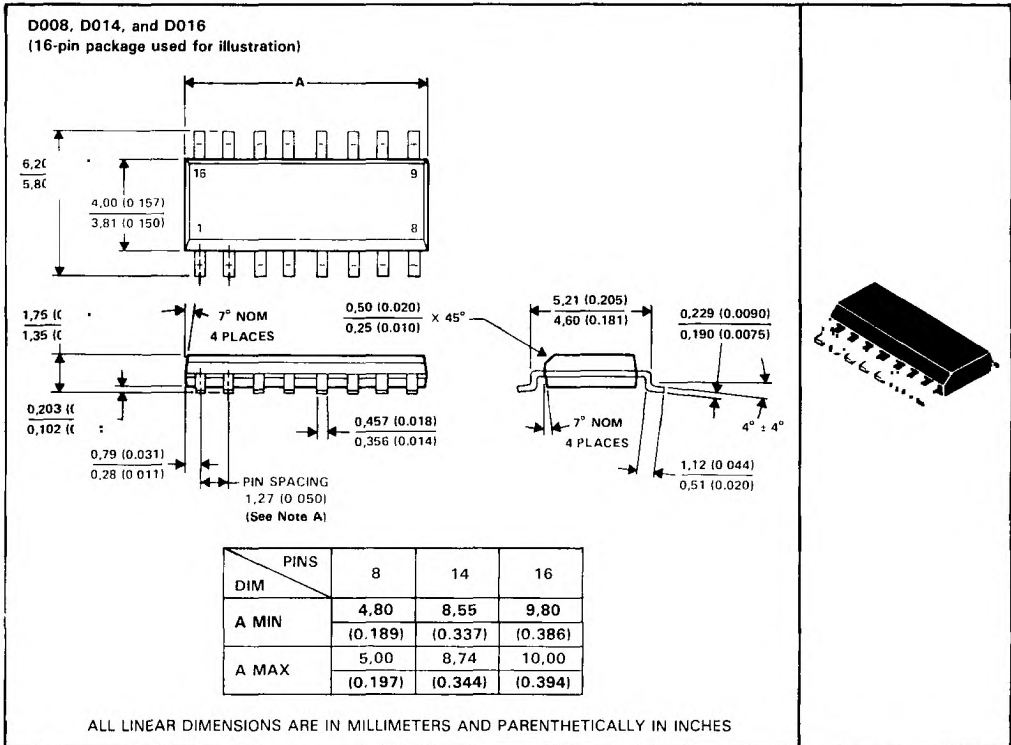

- NOTES: A. Leads are within 0,25 (0.010) radius of true position at maximum material dimension.  
 B. Body dimensions do not include mold flash or protrusion.  
 C. Mold flash or protrusion shall not exceed 0,15 (0.006).  
 D. Lead tips to be planar within ±0,051 (0.002) exclusive of solder.

3  
Mechanical Data

# MECHANICAL DATA

## DW016, DW020, DW024, and DW028 plastic "small outline" packages

Each of these "small outline" packages consists of a circuit mounted on a lead frame and encapsulated within a plastic compound. The compound will withstand soldering temperature with no deformation, and circuit performance characteristics will remain stable when operated in high-humidity conditions. Leads require no additional cleaning or processing when used in soldered assembly.

DW016, DW020, DW024, and DW028  
(20-pin package used for illustration)

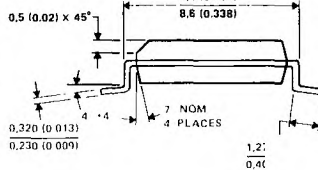
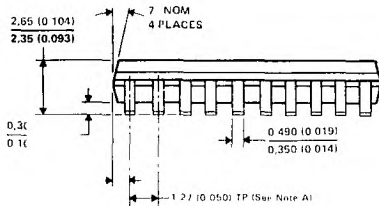
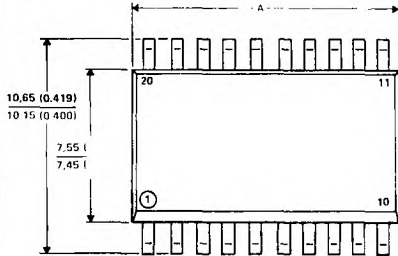

DIM \ PINS	16	20	24	28†
A MIN	10.16 (0.400)	12.70 (0.500)	15.24 (0.600)	17.68 (0.696)
A MAX	10.38 (0.411)	12.90 (0.508)	15.49 (0.610)	17.88 (0.704)

ALL LINEAR DIMENSIONS ARE IN MILLIMETERS AND PARENTHETICALLY IN INCHES

†The 28-pin package drawing is presently classified as Advance Information.

- NOTES: A. Leads are within 0,25 (0.010) radius of true position at maximum material dimension.  
 B. Body dimensions do not include mold flash or protrusion.  
 C. Mold flash or protrusion shall not exceed 0,15 (0.006).  
 D. Lead tips to be planar within ±0,051 (0.002) exclusive of solder.

**FK020 and FK028 ceramic chip carrier packages**

Each of these hermetically sealed chip carrier packages has a three-layer ceramic base with a metal lid and braze seal. The packages are intended for surface mounting on solder lands on 1,27 (0.050-inch) centers. terminals require no additional cleaning or processing when used in soldered assembly.

FK package terminal assignments conform to JEDEC Standards 1 and 2.

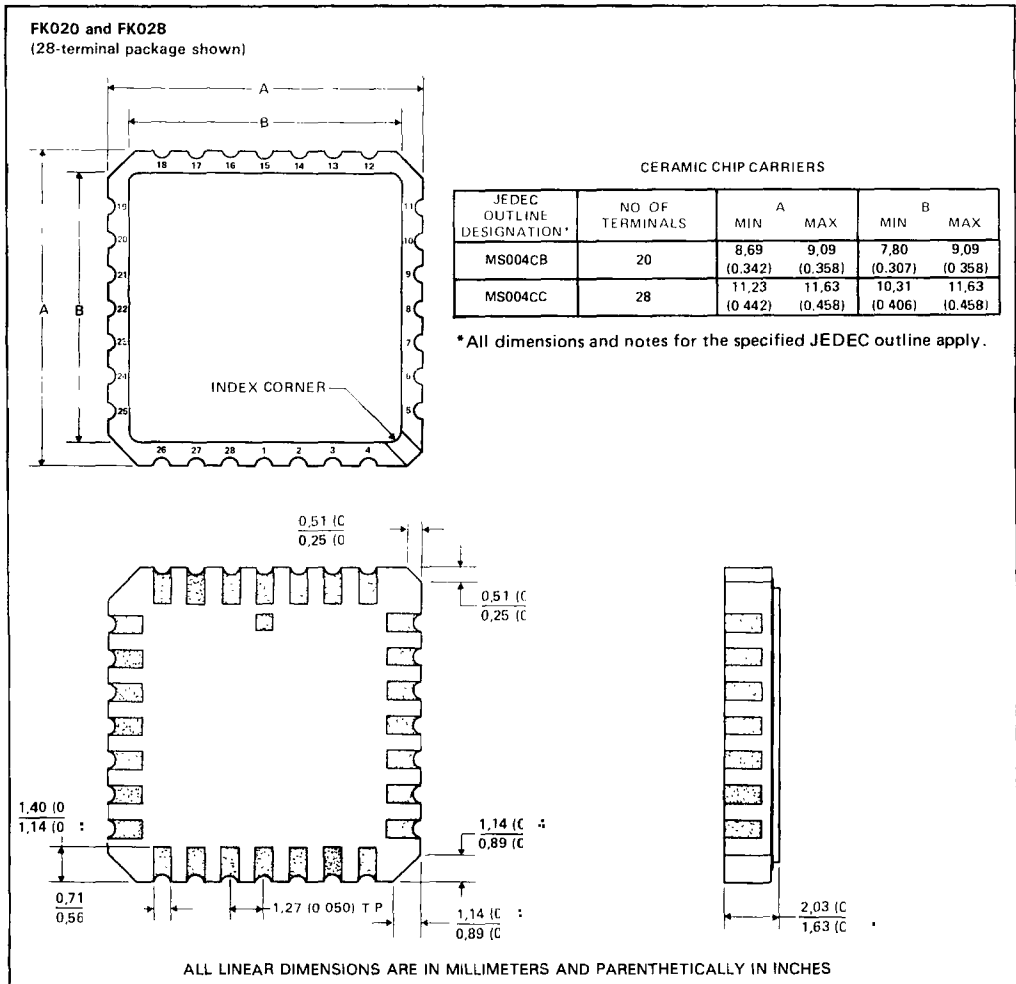

3  
Mechanical Data

## MECHANICAL DATA

### J014 ceramic dual-in-line package

This hermetically sealed dual-in-line package consists of a ceramic base, ceramic cap, and a lead frame. Hermetic sealing is accomplished with glass. The package is intended for insertion in mounting-hole rows on 7,62 (0.300) centers. Once the leads are compressed and inserted, sufficient tension is provided to secure the package in the board during soldering. Tin-plated ("bright-dipped") leads require no additional cleaning or processing when used in soldered assembly.

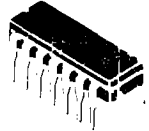
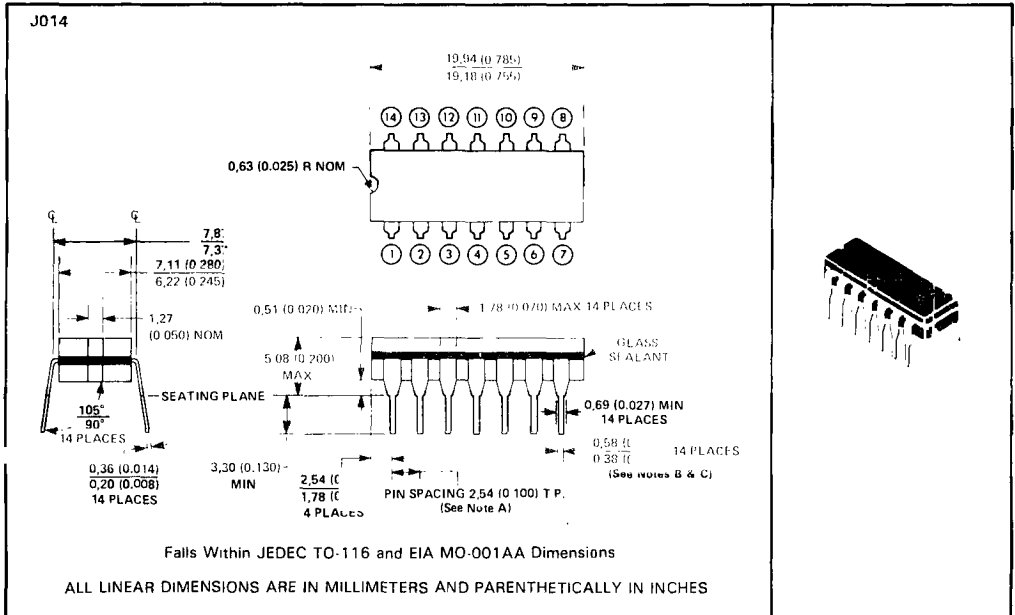

NOTES: A. Each pin centerline is located within 0,25 (0.010) of its true longitudinal position.

B. This dimension does not apply for solder-dipped leads.

C. When solder-dipped leads are specified, dipped area of the lead extends from the lead tip to at least 0,51 (0.020) above the seating plane.



**J016 ceramic dual-in-line package**

This hermetically sealed dual-in-line package consists of a ceramic base, ceramic cap, and a lead frame. Hermetic sealing is accomplished with glass. The package is intended for insertion in mounting-hole rows on 7,62 (0.300) centers. Once the leads are compressed and inserted, sufficient tension is provided to secure the package in the board during soldering. Tin-plated ("bright-dipped") leads require no additional cleaning or processing when used in soldered assembly.

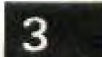
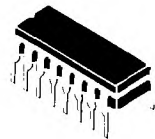
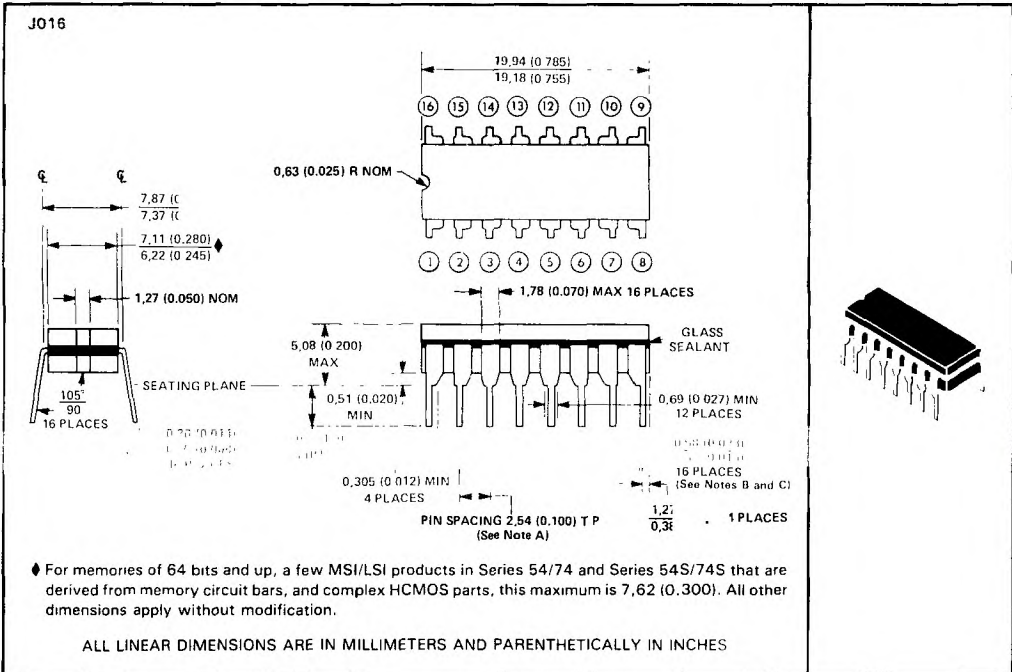

Mechanical Data

- NOTES: A. Each pin centerline is located within 0,25 (0.010) of its true longitudinal position.  
 B. This dimension does not apply for solder-dipped leads.  
 C. When solder-dipped leads are specified, dipped area of the lead extends from the lead tip to at least 0,51 (0.020) above the seating plane.

# MECHANICAL DATA

## J020 ceramic dual-in-line package

This hermetically sealed dual-in-line package consists of a ceramic base, ceramic cap, and a lead frame. Hermetic sealing is accomplished with glass. The package is intended for insertion in mounting-hole rows on 7,62 (0.300) centers. Once the leads are compressed and inserted, sufficient tension is provided to secure the package in the board during soldering. Tin-plated ("bright-dipped") leads require no additional cleaning or processing when used in soldered assembly.

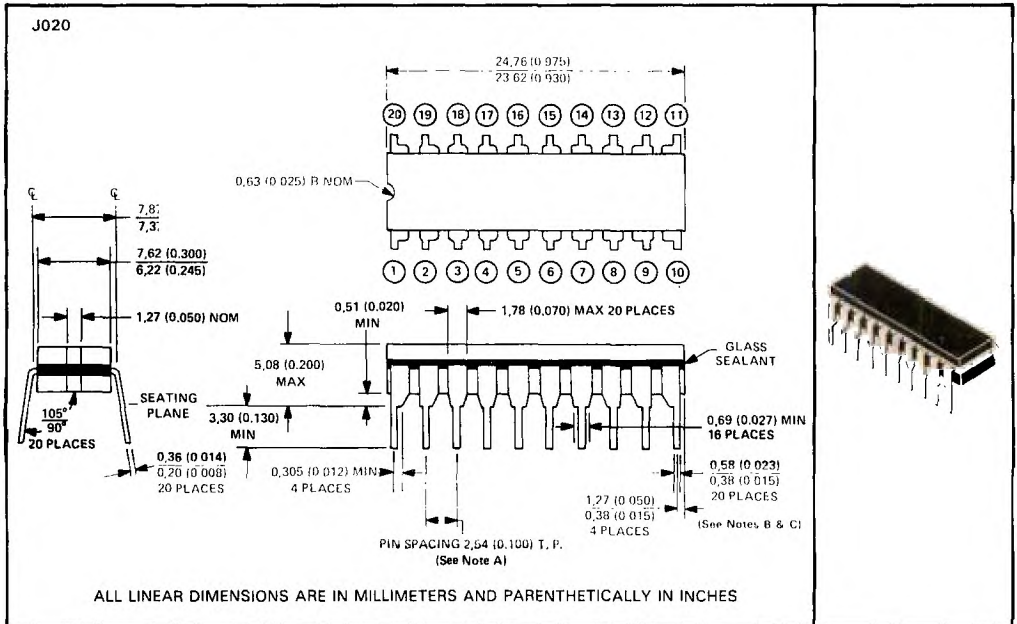

- NOTES:
- A. Each pin centerline is located within 0,25 (0.010) of its true longitudinal position.
  - B. This dimension does not apply for solder-dipped leads.
  - C. When solder-dipped leads are specified, dipped area of the lead extends from the lead tip to at least 0,51 (0.020) above the seating plane.

3 Mechanical Data

JT024 ceramic dual-in-line package

This hermetically sealed dual-in-line package consists of a ceramic base, ceramic cap, and a lead frame. Hermetic sealing is accomplished with glass. The package is intended for insertion in mounting-hole rows on 7,62 (0.300) centers. Once the leads are compressed and inserted, sufficient tension is provided to secure the package in the board during soldering. Tin-plated ("bright-dipped") leads require no additional cleaning or processing when used in soldered assembly.

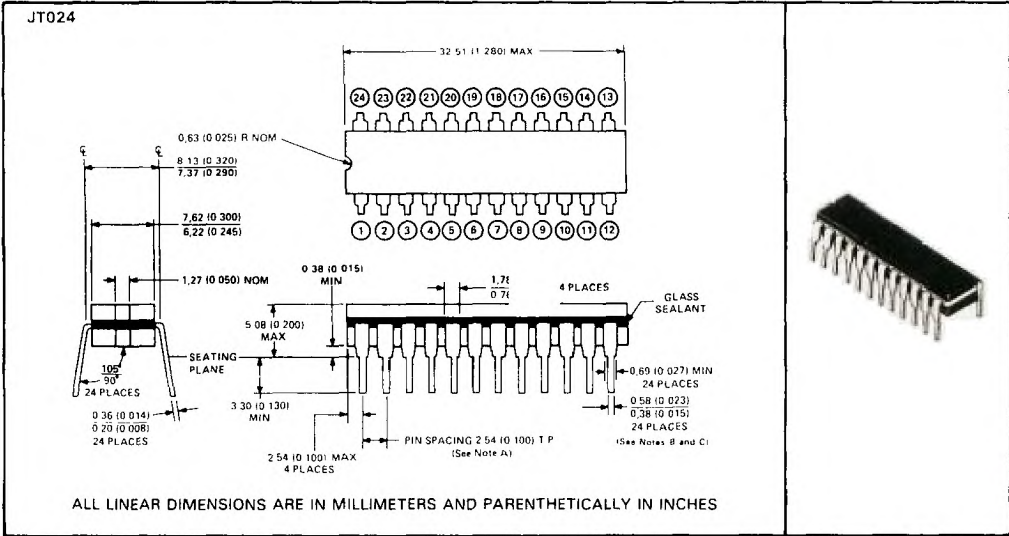

- NOTES:
- A. Each pin centerline is located within 0,25 (0.010) of its true longitudinal position.
  - B. This dimension does not apply for solder-dipped leads.
  - C. When solder-dipped leads are specified, dipped area of the lead extends from the lead tip to at least 0,51 (0.020) above the seating plane

3  
Mechanical Data

# MECHANICAL DATA

## JW024 ceramic dual-in-line package

This hermetically sealed dual-in-line package consists of a ceramic base, ceramic cap, and a lead frame. Hermetic sealing is accomplished with glass. The package is intended for insertion in mounting-hole rows on 15,24 (0.600) centers. Once the leads are compressed and inserted, sufficient tension is provided to secure the package in the board during soldering. Tin-plated ("bright-dipped") leads require no additional cleaning or processing when used in soldered assembly.

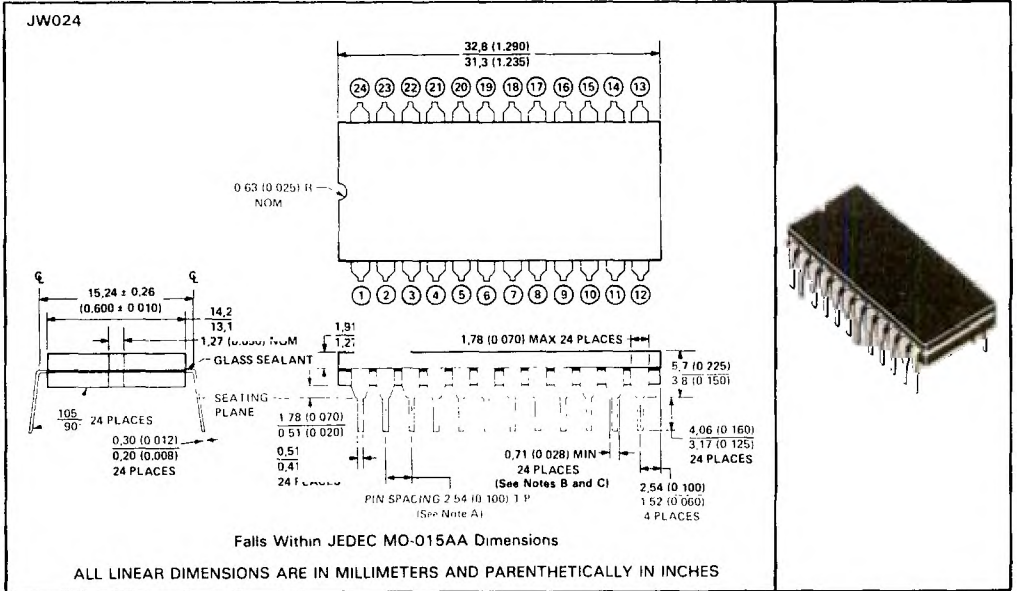

- NOTES:
- Each pin centerline is located within 0,25 (0.010) of its true longitudinal position.
  - This dimension does not apply for solder-dipped leads.
  - When solder-dipped leads are specified, dipped area of the lead extends from the lead tip to at least 0,51 (0.020) above the seating plane.

JD ceramic side-braze dual-in-line packages

This is a hermetically sealed ceramic package with a metal cap and side-brazed tin-plated leads.

JD016, JD018, JD020, JD022, JD024 (2 versions), JD028, JD040, JD048, JD052, and JD064

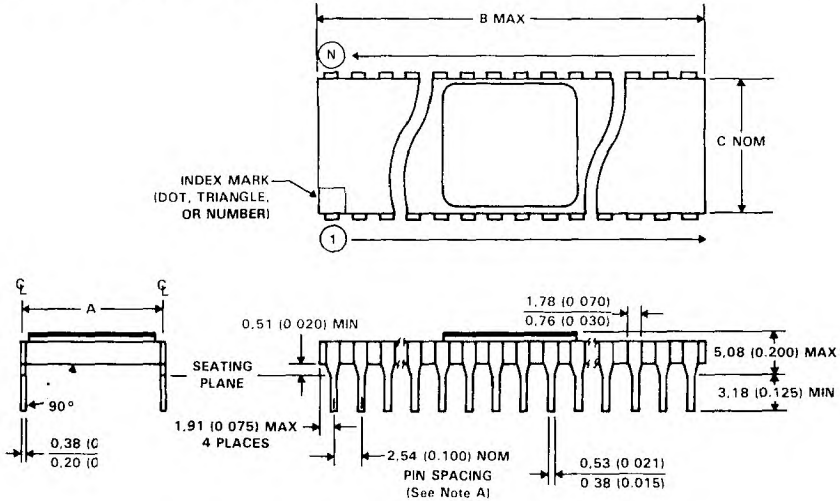

DIM	PINS (N)				
	16	18	20	22	24
A +0.51 (+0.020) -0.25 (-0.010)	7.62 (0.300)	7.62 (0.300)	7.62 (0.300)	10.16 (0.400)	7.62 (0.300)
B (MAX)	20.57 (0.810)	23.11 (0.910)	25.65 (1.010)	27.94 (1.100)	30.86 (1.215)
C (NOM)	7.37 (0.290)	7.37 (0.290)	7.37 (0.290)	9.91 (0.390)	7.37 (0.290)

DIM	PINS (N)					
	24	28	40	48	52	64
A +0.51 (+0.020) -0.25 (-0.010)	15.24 (0.600)	15.24 (0.600)	15.24 (0.600)	15.24 (0.600)	15.24 (0.600)	22.86 (0.900)
B (MAX)	31.8 (1.250)	36.8 (1.450)	52.1 (2.050)	62.2 (2.450)	67.3 (2.650)	82.6 (3.250)
C (NOM)	15.0 (0.590)	15.0 (0.590)	15.0 (0.590)	15.0 (0.590)	15.0 (0.590)	22.6 (0.890)

ALL LINEAR DIMENSIONS ARE IN MILLIMETERS AND PARENTHETICALLY IN INCHES

NOTE A: Each pin centerline is located within 0.25 (0.010) of its true longitudinal position.



# MECHANICAL DATA

## JG008 ceramic dual-in-line package

This hermetically sealed dual-in-line package consists of a ceramic base, ceramic cap, and an 8-pin lead frame. The package is intended for insertion in mounting-hole rows 7,62 (0.300) centers (see Note A). Once the leads are compressed and inserted, sufficient tension is provided to secure the package in the board during soldering.

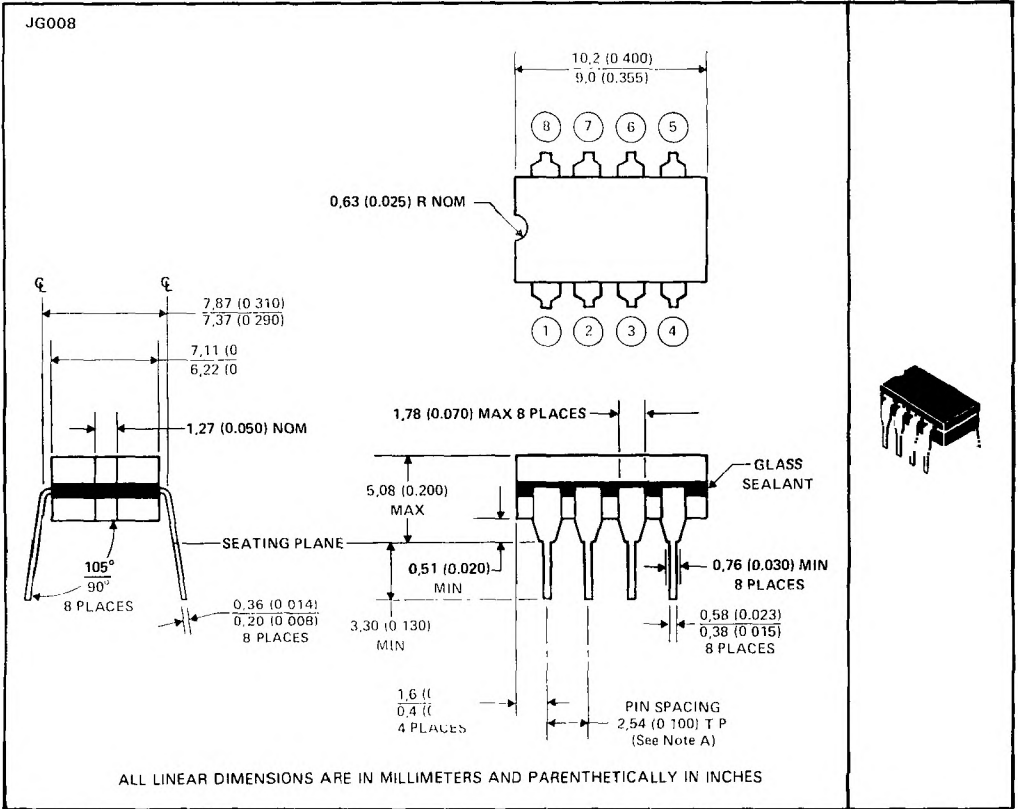

NOTE A: Each pin centerline is located within 0,25 (0.010) of its true longitudinal position.

Mechanical Data

**N014 plastic dual-in-line package**

This dual-in-line package consists of a circuit mounted on a lead frame and encapsulated within a plastic compound. The compound will withstand soldering temperature with no deformation, and circuit performance characteristics will remain stable when operated in high-humidity conditions. The package is intended for insertion in mounting-hole rows on 7,62 (0.300) centers (see Note A). Once the leads are compressed and inserted, sufficient tension is provided to secure the package in the board during soldering. Leads require no additional cleaning or processing when used in soldered assembly.

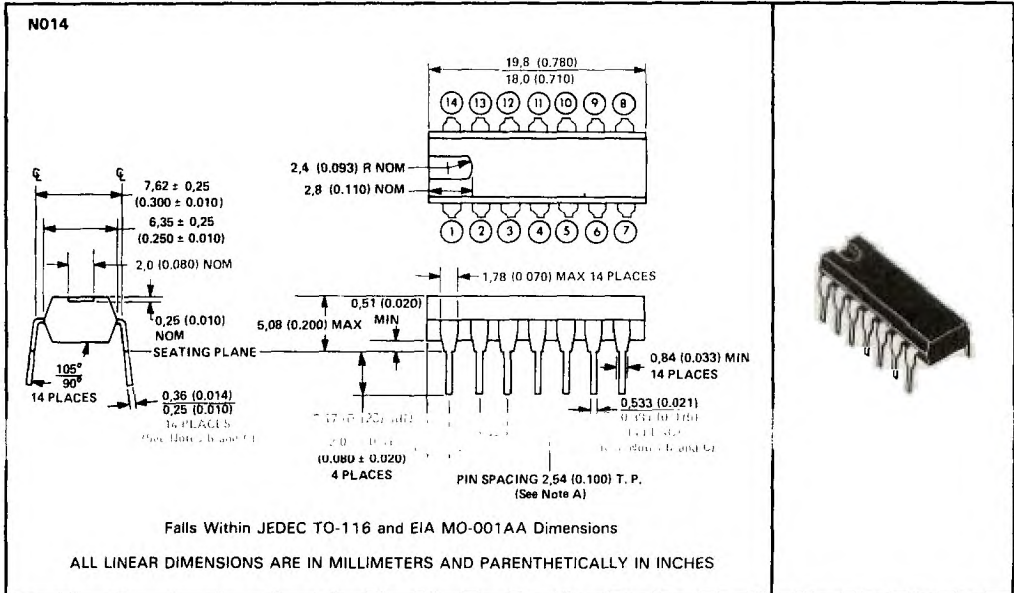

- NOTES: A. Each pin centerline is located within 0,25 (0,010) of its true longitudinal position.  
 B. This dimension does not apply for solder-dipped leads.  
 C. When solder-dipped leads are specified, dipped area of the lead extends from the lead tip to at least 0,51 (0,020) above seating plane.

3  
Mechanical Data

# MECHANICAL DATA

## N016 plastic dual-in-line package

This dual-in-line package consists of a circuit mounted on a lead frame and encapsulated within an electrically nonconductive plastic compound. The compound will withstand soldering temperature with no deformation, and circuit performance characteristics will remain stable when operated in high-humidity conditions. The package is intended for insertion in mounting-hole rows on 7,62 (0.300) centers. Once the leads are compressed and inserted, sufficient tension is provided to secure the package in the board during soldering. Leads require no additional cleaning or processing when used in soldered assembly.

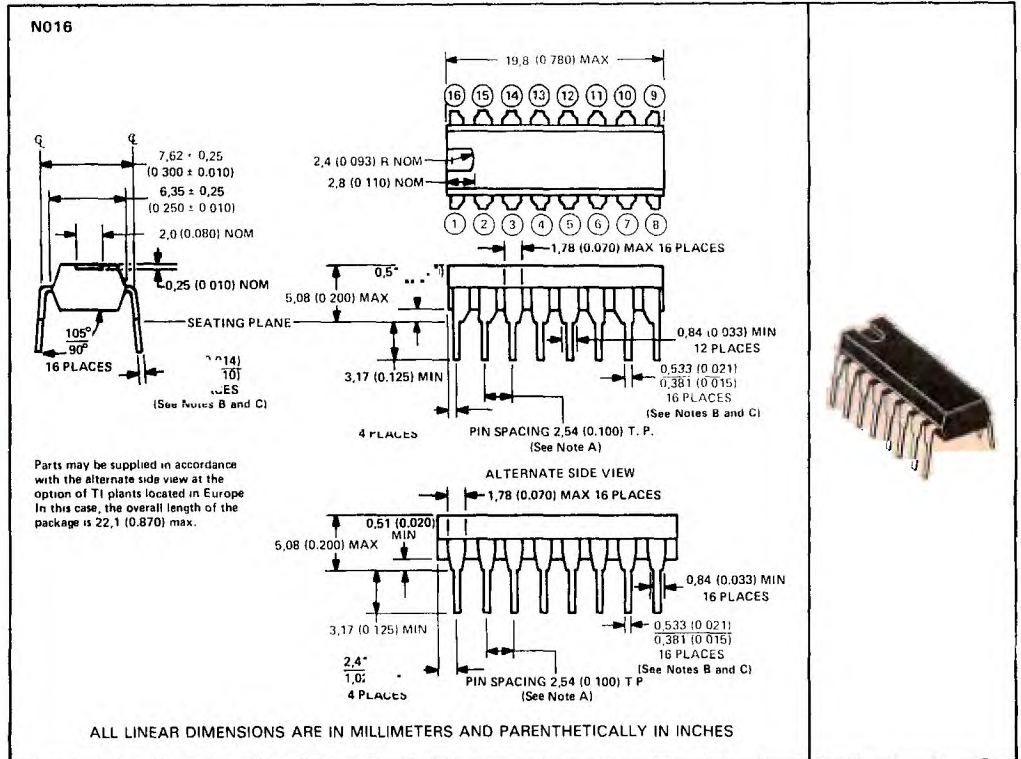

3

Mechanical Data



**N020 plastic dual-in-line package**

This dual-in-line package consists of a circuit mounted on a lead frame and encapsulated within an electrically nonconductive plastic compound. The compound will withstand soldering temperature with no deformation, and circuit performance characteristics will remain stable when operated in high-humidity conditions. The package is intended for insertion in mounting-hole rows on 7,62 (0.300) centers. Once the leads are compressed and inserted, sufficient tension is provided to secure the package in the board during soldering. Leads require no additional cleaning or processing when used in soldered assembly.

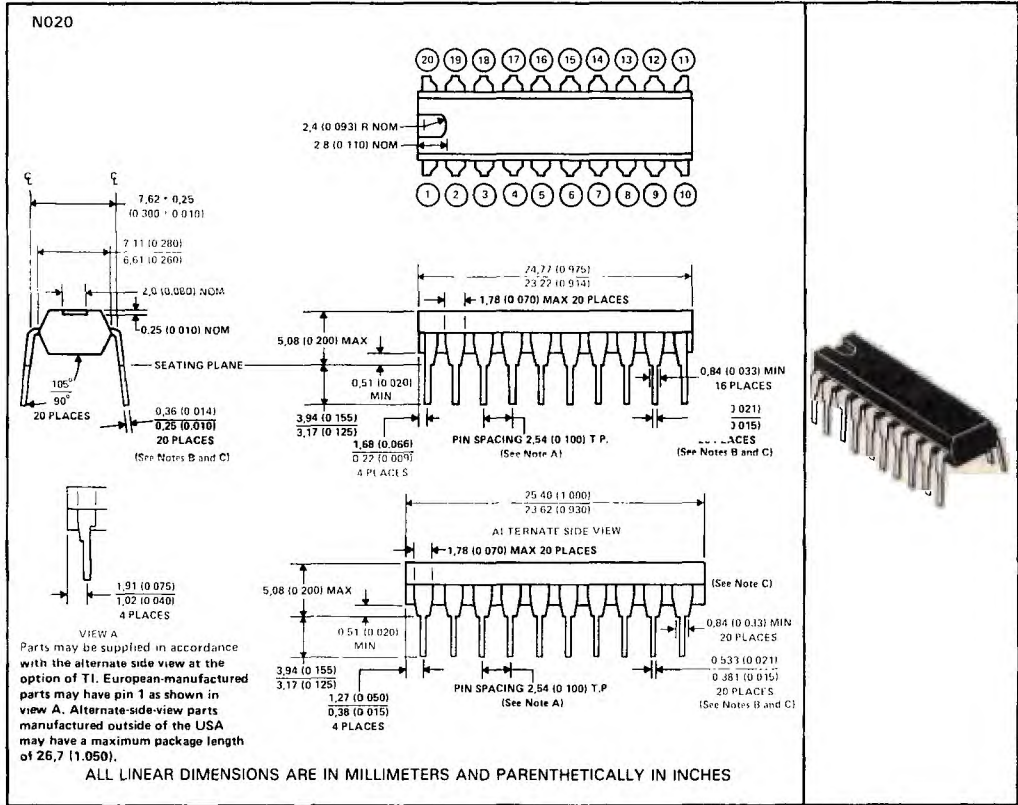

3  
 Mechanical Data

- NOTES: A. Each pin centerline is located within 0,25 (0.010) of its true longitudinal position.  
 B. This dimension does not apply for solder-dipped leads.  
 C. When solder-dipped leads are specified, dipped area of the lead extends from the lead tip to at least 0,51 (0.020) above seating plane.

# MECHANICAL DATA

## N028 plastic dual-in-line package

This dual-in-line package consists of a circuit mounted on a lead frame and encapsulated within an electrically nonconductive plastic compound. The compound will withstand soldering temperature with no deformation, and circuit performance characteristics will remain stable when operated in high-humidity conditions. The package is intended for insertion in mounting-hole rows on 15,24 (0.600) centers. Once the leads are compressed and inserted, sufficient tension is provided to secure the package in the board during soldering. Leads require no additional cleaning or processing when used in soldered assembly.

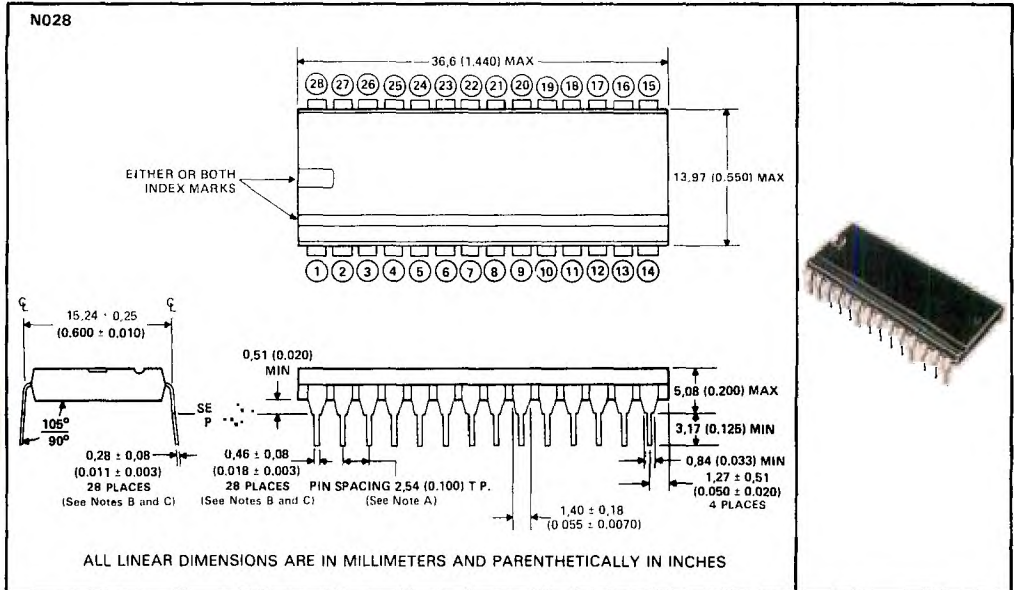

- NOTES: A. Each pin centerline is located within 0.25 (0.010) of its true longitudinal position.  
 B. This dimension does not apply for solder-dipped leads.  
 C. When solder-dipped leads are specified, dipped area of the lead extends from the lead tip to at least 0.51 (0.020) above seating plane.

3

Mechanical Data

**N040 plastic dual-in-line package**

This dual-in-line package consists of a circuit mounted on a lead frame and encapsulated within an electrically nonconductive plastic compound. The compound will withstand soldering temperature with no deformation, and circuit performance characteristics will remain stable when operated in high-humidity conditions. The package is intended for insertion in mounting-hole rows on 15,24 (0.600) centers. Once the leads are compressed and inserted, sufficient tension is provided to secure the package in the board during soldering. Leads require no additional cleaning or processing when used in soldered assembly.

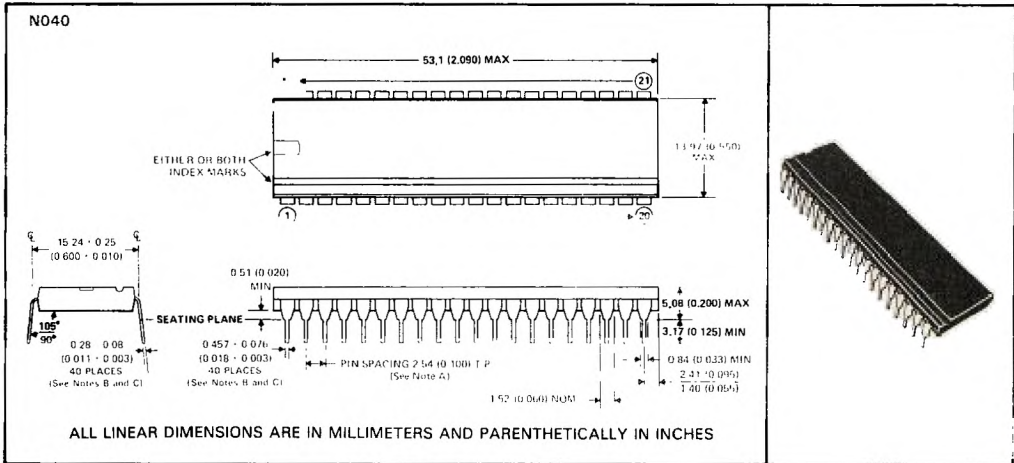

- NOTES: A. Each pin centerline is located within 0,25 (0.010) of its true longitudinal position.  
 B. This dimension does not apply for solder-dipped leads.  
 C. When solder-dipped leads are specified, dipped area of the lead extends from the lead tip to at least 0,51 (0.020) above seating plane.

3  
Mechanical Data

# MECHANICAL DATA

## NT024 plastic dual-in-line package

This dual-in-line package consists of a circuit mounted on a lead frame and encapsulated within an electrically nonconductive plastic compound. The compound will withstand soldering temperature with no deformation, and circuit performance characteristics will remain stable when operated in high-humidity conditions. The package is intended for insertion in mounting-hole rows on 7,62 (0.300) centers. Once the leads are compressed and inserted, sufficient tension is provided to secure the package in the board during soldering. Leads require no additional cleaning or processing when used in soldered assembly.

NOTE: For all except 24-pin packages, the letter N is used by itself since only the 24-pin package is available in more than one row-spacing. For the 24-pin package, the 7,62 (0.300) version is designated NT; the 15,24 (0.600) version is designated NW. If no second letter or row-spacing is specified, the package is assumed to have 15,24 (0.600) row-spacing.

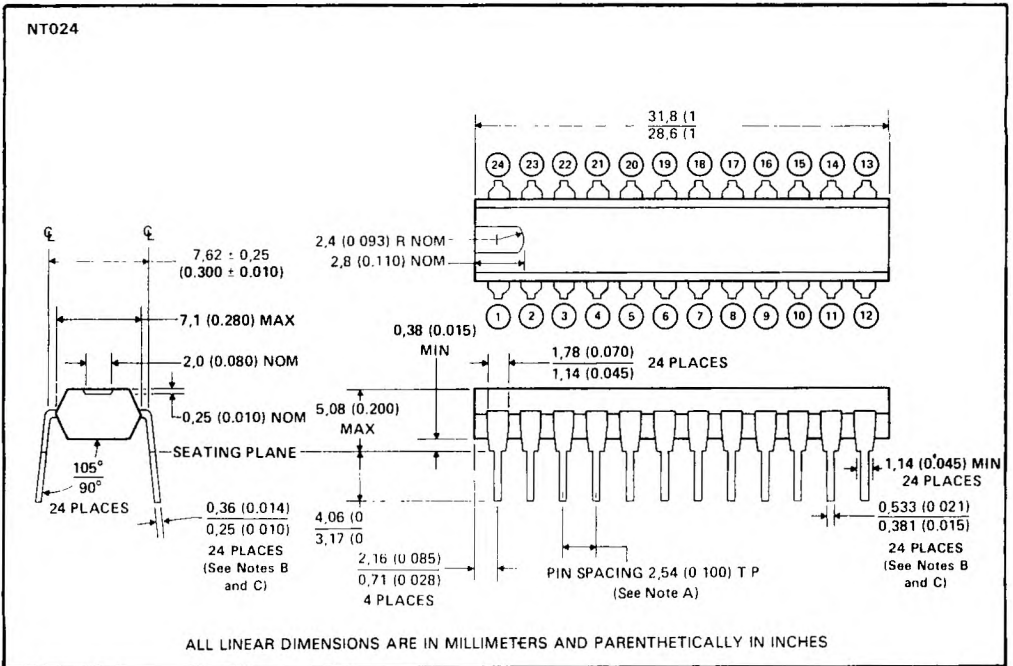

- NOTES: A. Each pin centerline is located within 0,25 (0.010) of its true longitudinal position.  
 B. This dimension does not apply for solder-dipped leads.  
 C. When solder-dipped leads are specified, dipped area of the lead extends from the lead tip to at least 0,51 (0.020) above the seating plane.

3 Mechanical Data



NW024 plastic dual-in-line package

This dual-in-line package consists of a circuit mounted on a lead frame and encapsulated within an electrically nonconductive plastic compound. The compound will withstand soldering temperature with no deformation, and circuit performance characteristics will remain stable when operated in high-humidity conditions. The package is intended for insertion in mounting-hole rows on 15,24 (0.600) centers. Once the leads are compressed and inserted, sufficient tension is provided to secure the package in the board during soldering. Leads require no additional cleaning or processing when used in soldered assembly.

NOTE: For all except 24-pin packages, the letter N is used by itself since only the 24-pin package is available in more than one row-spacing. For the 24-pin package, the 7,62 (0.300) version is designated NT; the 15,24 (0.600) version is designated NW. If no second letter or row-spacing is specified, the package is assumed to have 15,24 (0.600) row-spacing.

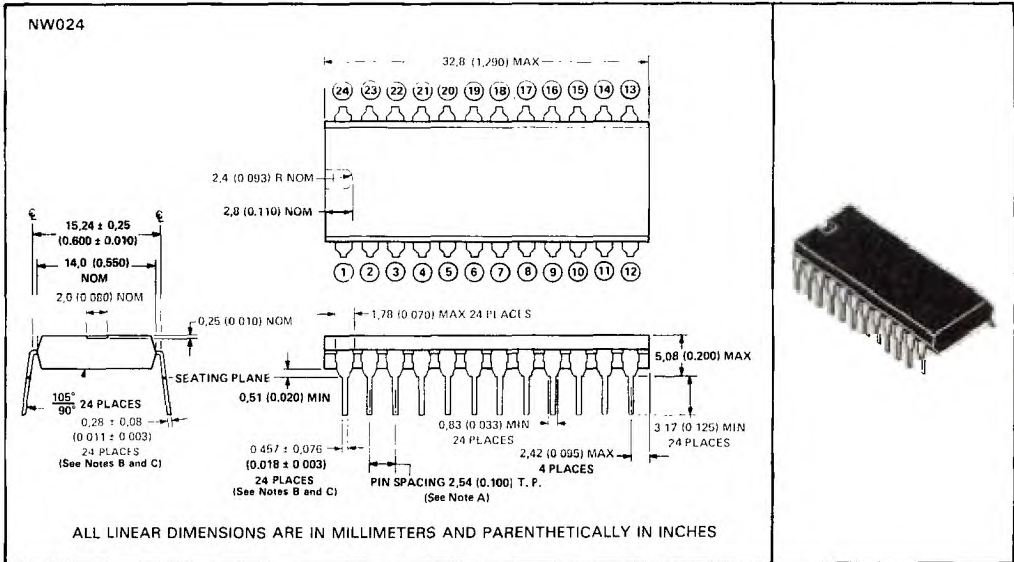

3

Mechanical Data

- NOTES: A. Each pin centerline is located within 0,25 (0.010) of its true longitudinal position.  
 B. This dimension does not apply for solder-dipped leads.  
 C. When solder-dipped leads are specified, dipped area of the lead extends from the lead tip to at least 0,51 (0.020) above seating plane.

# MECHANICAL DATA

## P008 dual-in-line plastic package

This package consists of a circuit mounted on an 8-pin lead frame and encapsulated within a plastic compound. The compound will withstand soldering temperature with no deformation, and circuit performance characteristics will remain stable when operated in high-humidity conditions. The package is intended for insertion in mounting-hole rows on 7,62 (0.300) centers (See Note A). Once the leads are compressed and inserted, sufficient tension is provided to secure the package in the board during soldering. Solder-plated leads require no additional cleaning or processing when used in soldered assembly.

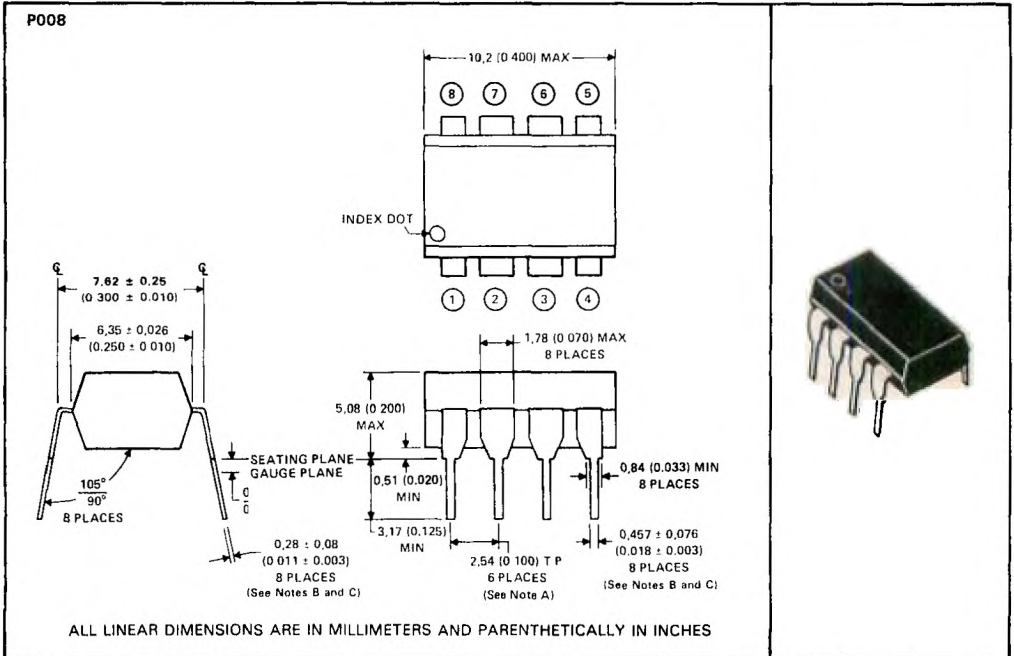

3  
Mechanical Data

- NOTES: A. Each pin centerline is located within 0,25 (0.010) of its true longitudinal position.  
B. This dimension does not apply for solder-dipped leads.  
C. When solder-dipped leads are specified, dipped area of the lead extends from the lead tip to at least 0,51 (0.020) above seating plane.

W014 ceramic flat package

This hermetically sealed flat package consists of an electrically nonconductive ceramic base and cap and a lead frame. Hermetic sealing is accomplished with glass. Leads require no additional cleaning or processing when used in soldered assembly.

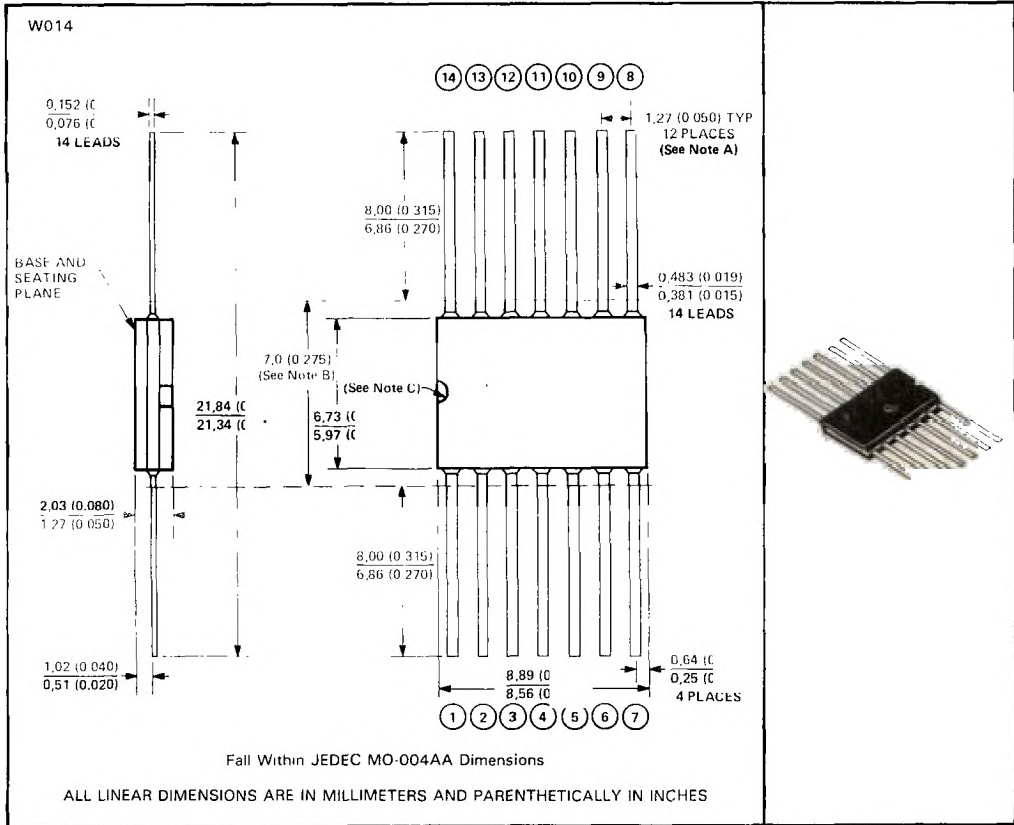

Mechanical Data

- NOTES: A. Leads are within 0,13 (0.005) radius of true position (T.P.) at maximum material condition.  
 B. This dimension determines a zone within which all body and lead irregularities lie.  
 C. Index point is provided on cap for terminal identification only.

# MECHANICAL DATA

## W016 ceramic flat packages

This hermetically sealed flat package consists of an electrically nonconductive ceramic base and cap and a lead frame. Hermetic sealing is accomplished with glass. Leads require no additional cleaning or processing when used in soldered assembly.

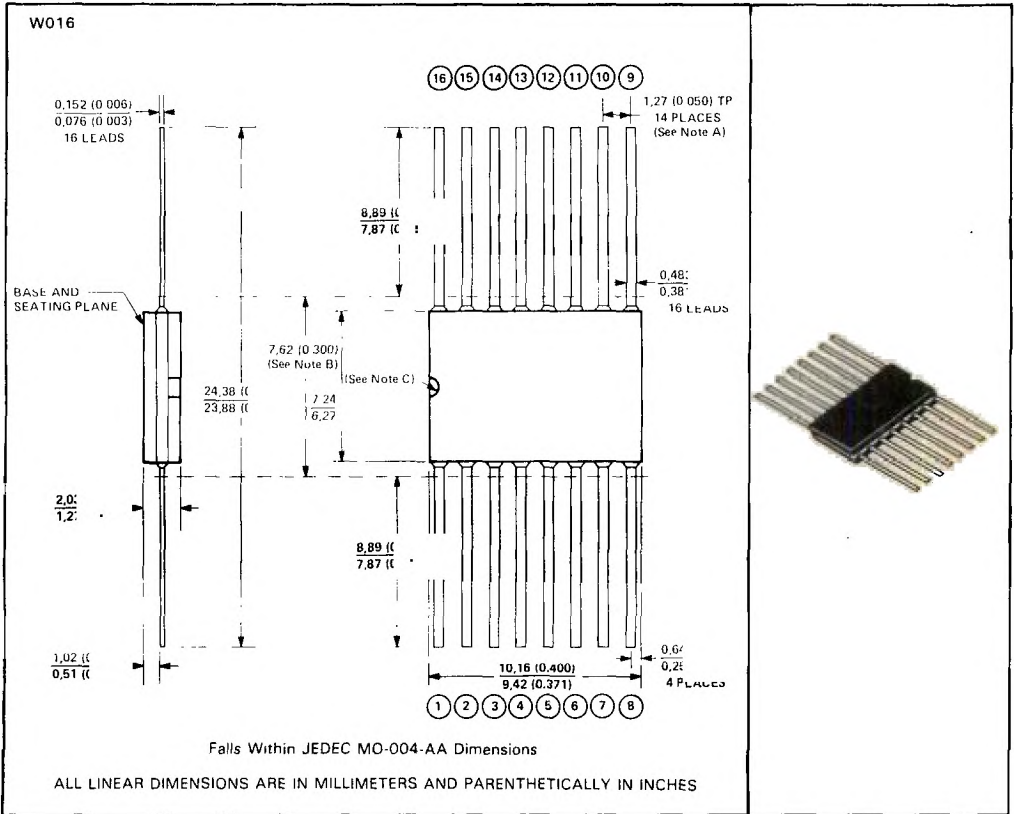

- NOTES: A. Leads are within 0.13 (0.005) radius of true position (T.P.) at maximum material condition.  
 B. This dimension determines a zone within which all body and lead irregularities lie.  
 C. Index point is provided on cap for terminal identification only.



Mechanical Data



W024 ceramic flat package

This hermetically sealed flat package consists of an electrically nonconductive ceramic base and cap and a lead frame. Hermetic sealing is accomplished with glass. Leads require no additional cleaning or processing when used in soldered assembly.

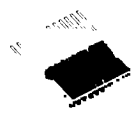
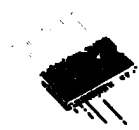
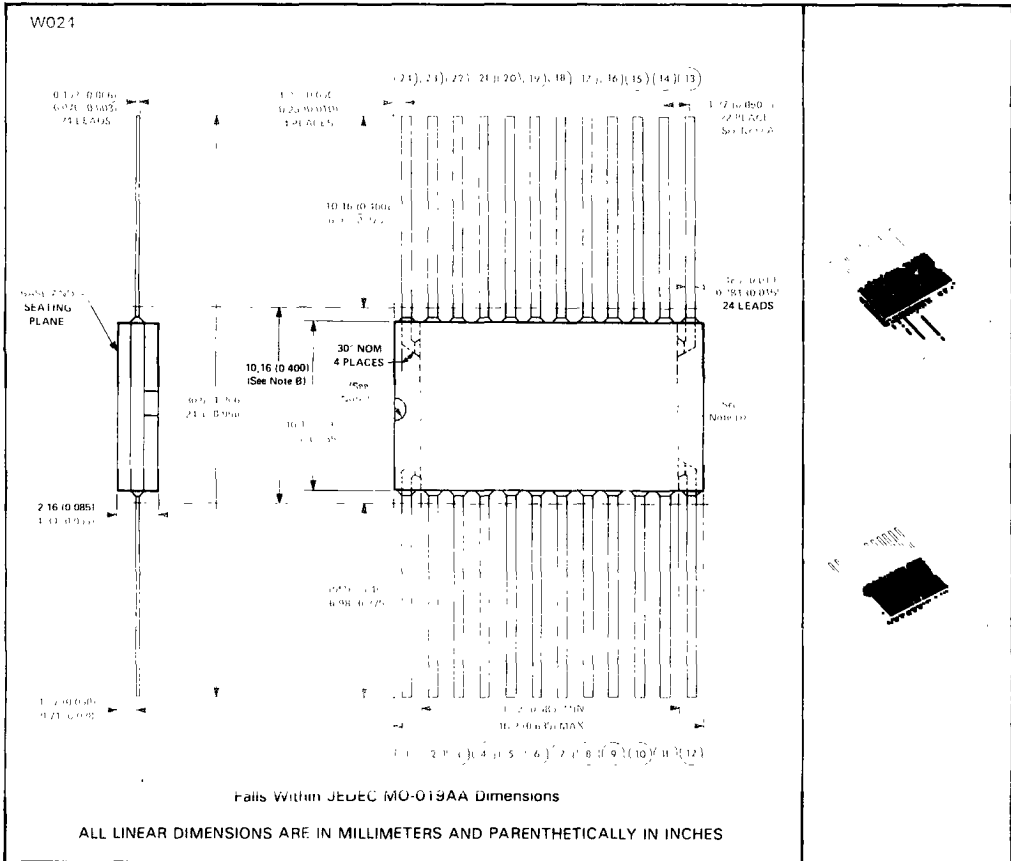

Mechanical Data

- NOTES:
- A. Leads are within 0.13 (0.005) radius of true position (T.P.) at maximum material condition.
  - B. This dimension determines a zone within which all body and lead irregularities lie
  - C. Index point is provided on cap for terminal identification only
  - D. End configuration of 24-pin package is at the option of TI



## Mechanical Data